

# GESAP

SALOTTI



# OLIMPIA

---

trasformabile



Struttura in legno di abete e agglomerati di particelle di legno.

Braccia e spalliera agganciati con meccanismo a baionetta.

Sistema apertura rete tipo roller con reggiguanciali.

Rete elettrosaldata e materasso in poliuretano espanso h. cm 13

Imbottitura di poliuretano espanso a densità differenziata.

Rivestimento tessuto/ecopelle

Divano interamente sfoderabile

Senza chaise longue

# OLIMPIA

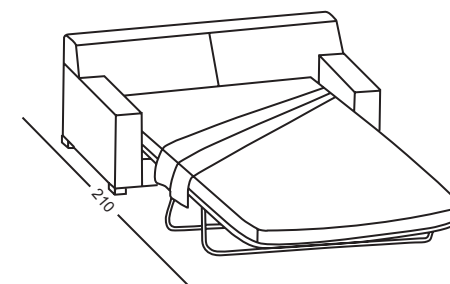
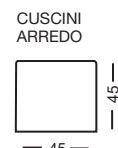
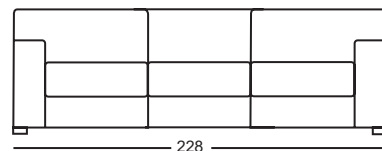
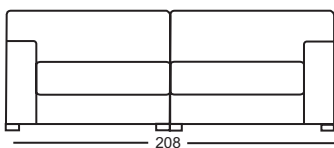
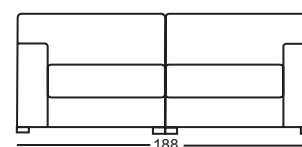
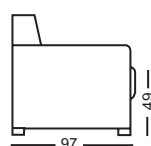
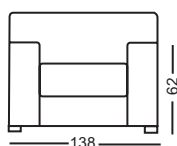
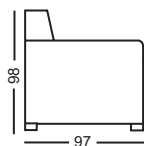

# PEDRO

---

trasformabile



Struttura in legno di abete e agglomerati di particelle di legno.

Braccia e spalliera agganciati con meccanismo a baionetta.

Sistema apertura rete tipo roller con reggiangiali e poggiatesta.

Rete elettrosaldata e materasso in poliuretano espanso h. cm 13

Imbottitura di poliuretano espanso a densità differenziata.

Rivestimento tessuto/ecopelle

Divano interamente sfoderabile

Inserimento chaise longue con contenitore e senza contenitore con aggiunta cm 82 alla misura del divano

# PEDRO

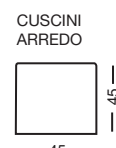
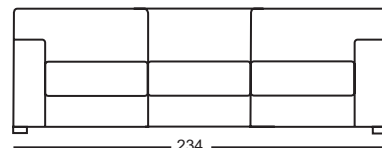
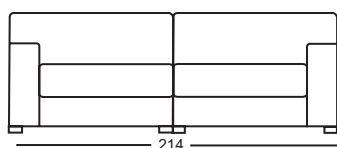
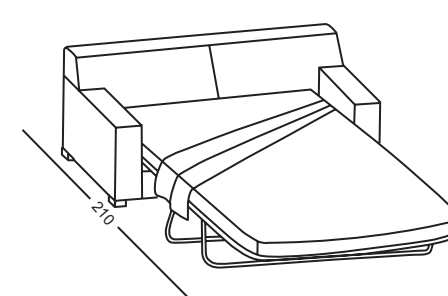
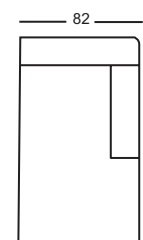
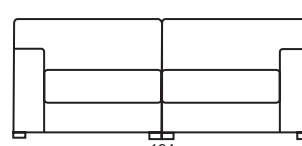
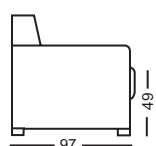
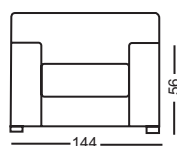
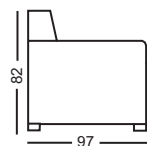
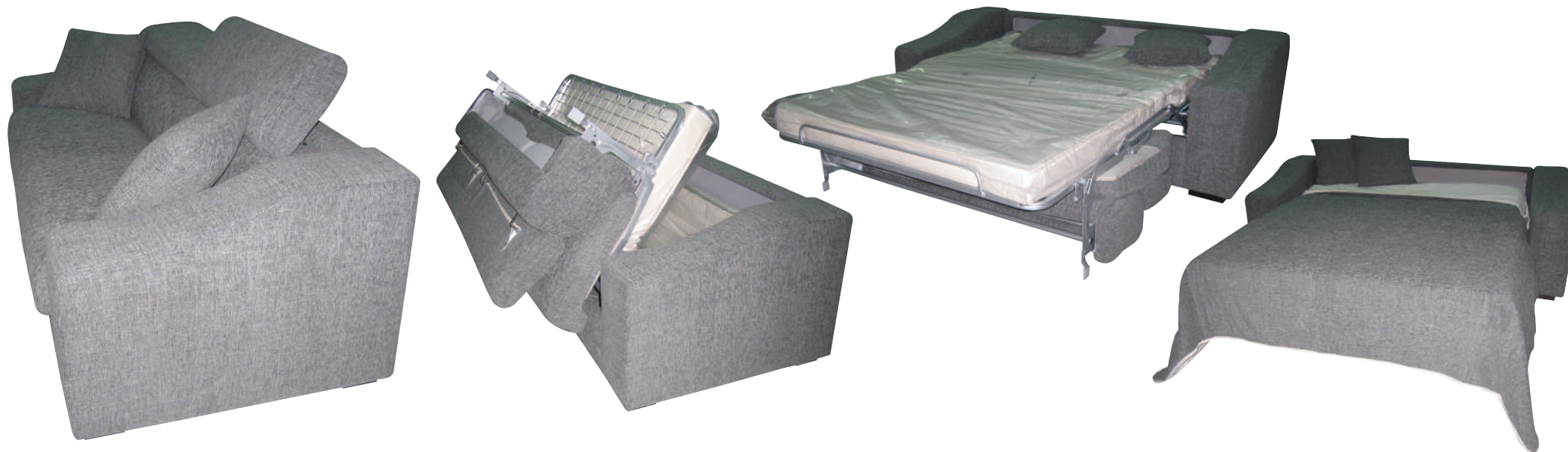

CUSCINI ARREDO

# SAFIRA

trasformabile



Struttura in legno di abete e agglomerati di particelle di legno.

Braccia e spalliera agganciati con meccanismo a baionetta.

Rete elettrosaldata e materasso in poliuretano espanso h. cm 13

Imbottitura di poliuretano espanso a densità differenziata.

Rivestimento tessuto/ecopelle

Divano interamente sfoderabile

Senza chaise longue

# SAFIRA

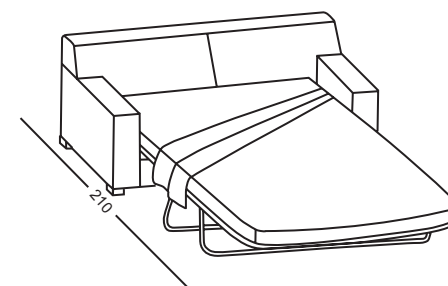
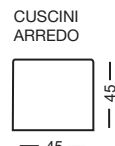
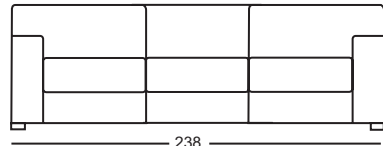
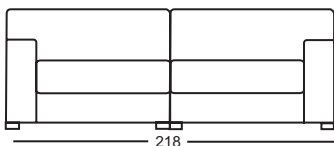
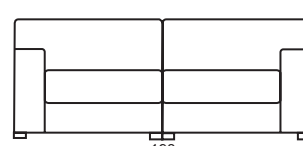
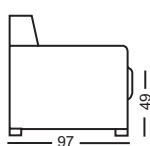
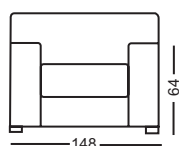
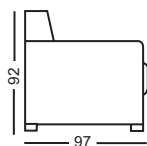

# GILBERTO

trasformabile





Struttura in legno di abete e agglomerati di particelle di legno.

Braccia e spalliera agganciati con meccanismo a baionetta.

Sistema apertura rete tipo roller con reggiguanciali.

Rete elettrosaldata e materasso in poliuretano espanso h. cm 13

Imbottitura di poliuretano espanso a densità differenziata.

Rivestimento tessuto/ecopelle

Divano interamente sfoderabile

Inserimento chaise longue con contenitore e senza contenitore con aggiunta cm 82 alla misura del divano

# GILBERTO

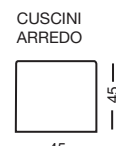
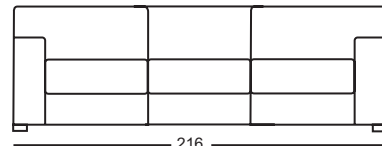
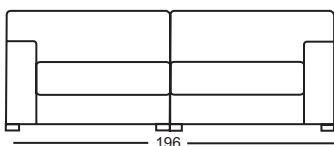
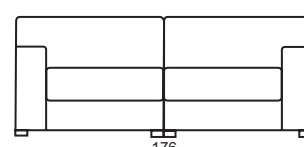
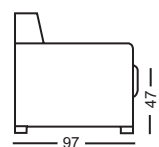
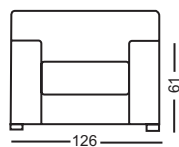
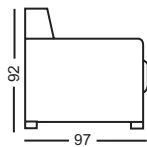

CUSCINI  
ARREDO

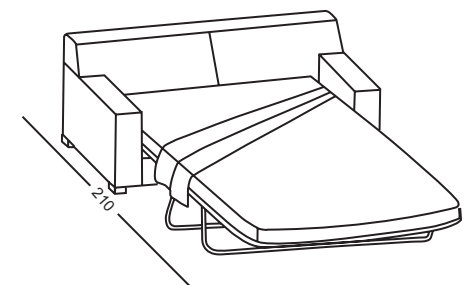
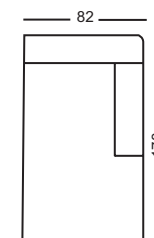

# GILBERTO

trasformabile

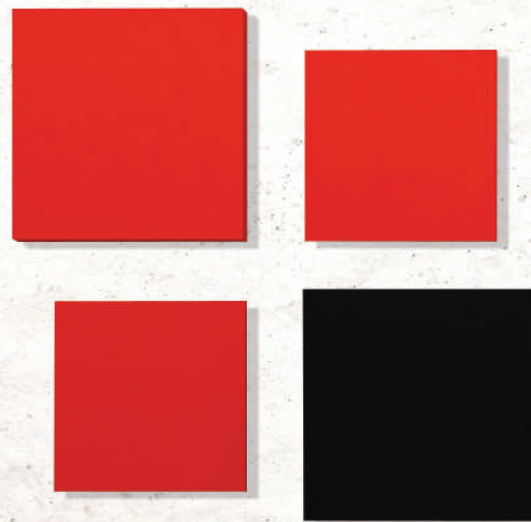

# GILBERTO



*Struttura in legno di abete e agglomerati di particelle di legno.*

*Braccia e spalliera agganciati con meccanismo a baionetta.*

*Sistema apertura rete tipo roller con reggiuanciali.*

*Rete elettrosaldata e materasso in poliuretano espanso h. cm 13*

*Imbottitura di poliuretano espanso a densità differenziata.*

*Rivestimento tessuto/ecopelle*

*Divano interamente sfoderabile*

*Inserimento chaise longue con contenitore e senza contenitore con aggiunta cm 82 alla misura del divano*

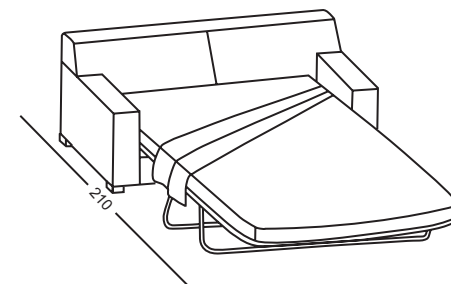
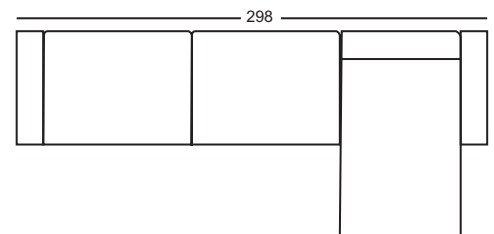
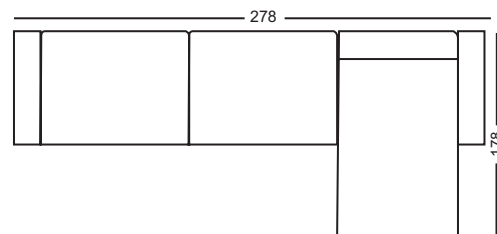
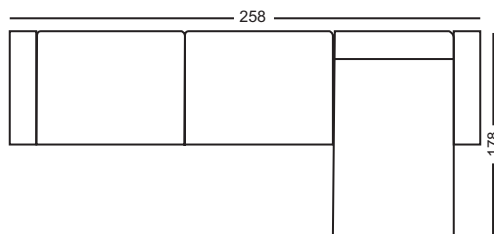
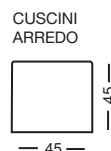
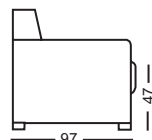
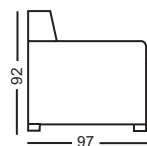

# CANDIDO

trasformabile



Struttura in legno di abete e agglomerati di particelle di legno.

Braccia e spalliera agganciati con meccanismo a baionetta.

Sistema apertura rete tipo roller con reggiguanciali.

Rete elettrosaldata e materasso in poliuretano espanso h. cm 13

Imbottitura di poliuretano espanso a densità differenziata.

Rivestimento tessuto/ecopelle

Divano interamente sfoderabile

Inserimento chaise longue con contenitore e senza contenitore con aggiunta cm 82 alla misura del divano

# CANDIDO

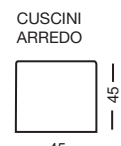
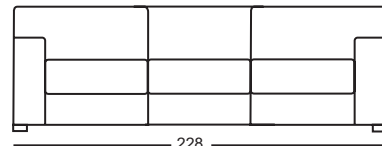
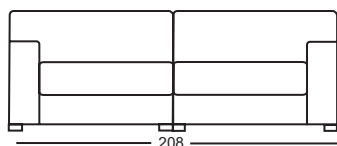
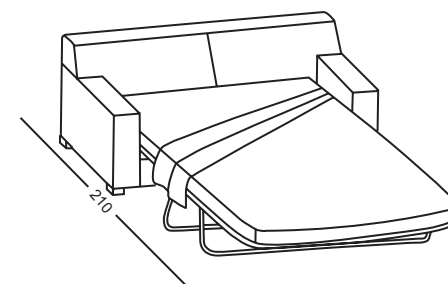
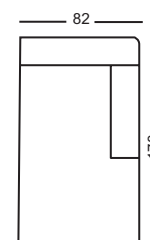
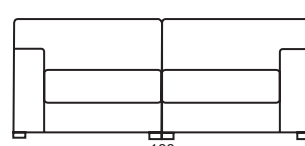
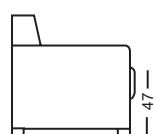
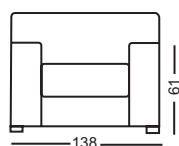
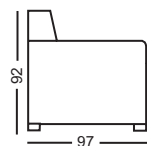

CUSCINI  
ARREDO

# NADIR

---

trasformabile



Struttura in legno di abete e agglomerati di particelle di legno.

Braccia e spalliera agganciati con meccanismo a baionetta.

Sistema apertura rete tipo roller con reggiguanciali.

Rete elettrosaldata e materasso in poliuretano espanso h. cm 13

Imbottitura di poliuretano espanso a densità differenziata.

Rivestimento tessuto/ecopelle

Divano interamente sfoderabile

Inserimento chaise longue con contenitore e senza contenitore con aggiunta cm 82 alla misura del divano

# NADIR

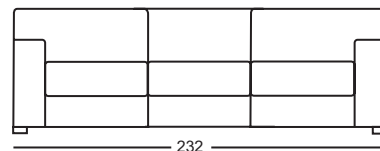
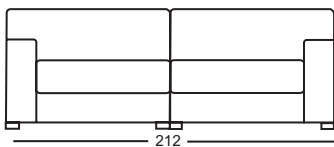
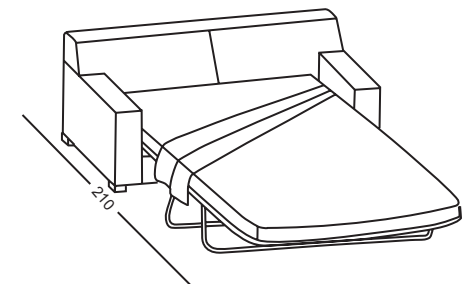
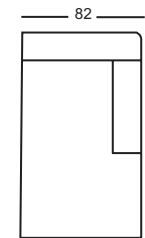
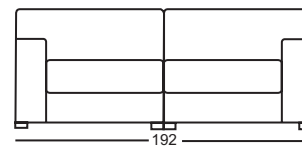
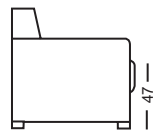
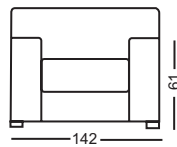
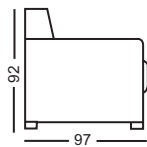

# NESTOR

trasformabile





Struttura in legno di abete e agglomerati di particelle di legno.

Braccia e spalliera agganciati con meccanismo a baionetta.

Sistema apertura rete tipo roller con reggiguanciali.

Rete elettrosaldata e materasso in poliuretano espanso h. cm 13

Imbottitura di poliuretano espanso a densità differenziata.

Rivestimento tessuto/ecopelle

Divano interamente sfoderabile

Inserimento chaise longue con contenitore e senza contenitore con aggiunta cm 82 alla misura del divano

# NESTOR

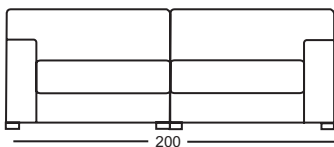
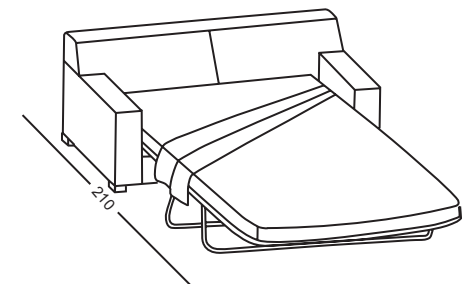
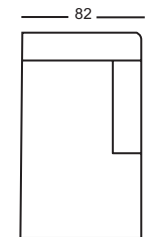
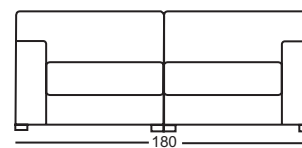
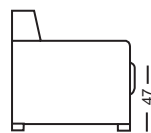
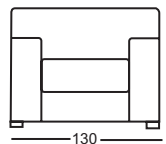
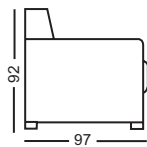

# CLODOMIRO

trasformabile

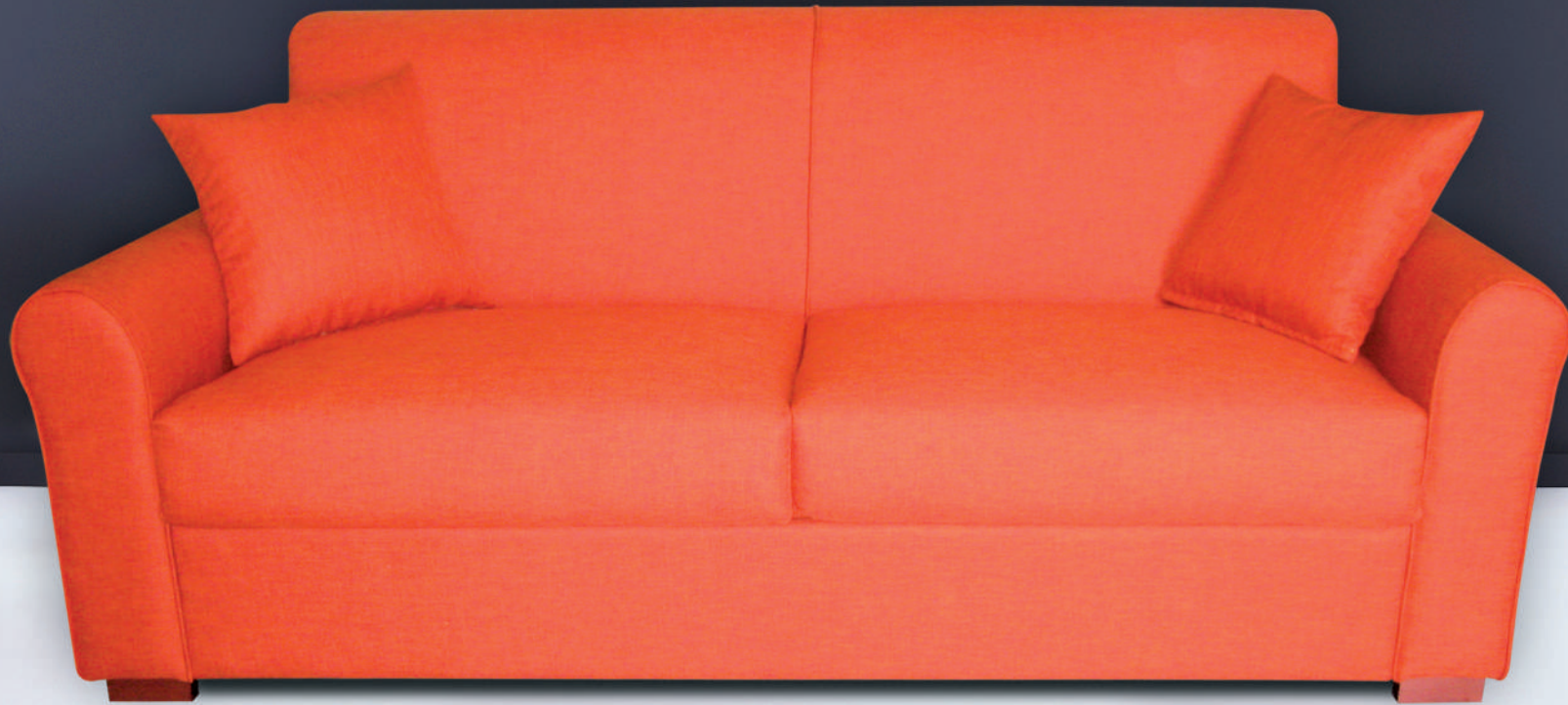
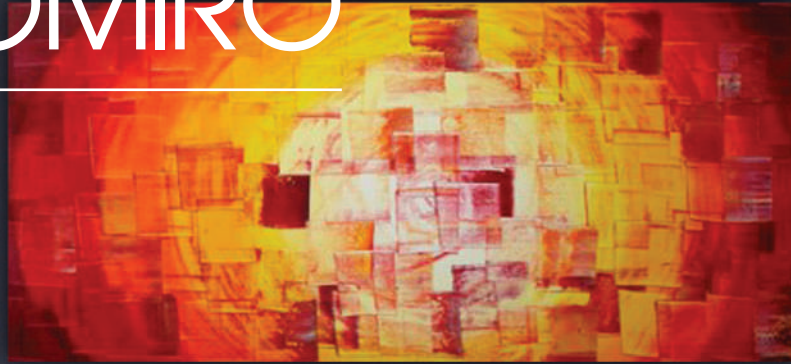

Struttura in legno di abete e agglomerati di particelle di legno.

Braccia e spalliera agganciati con meccanismo a baionetta.

Sistema apertura rete tipo roller con reggiunguali.

Rete elettrosaldata e materasso in poliuretano espanso h. cm 13

Imbottitura di poliuretano espanso a densità differenziata.

Rivestimento tessuto/ecopelle

Divano interamente sfoderabile

Inserimento chaise longue con contenitore e senza contenitore con aggiunta cm 82 alla misura del divano

# CLODOMIRO

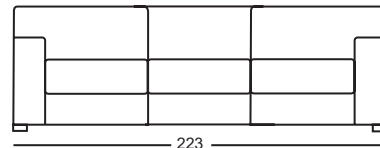
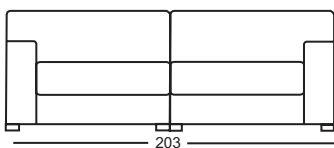
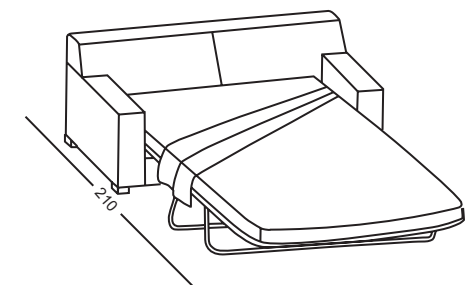
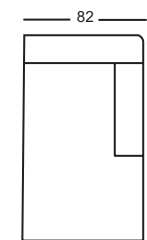
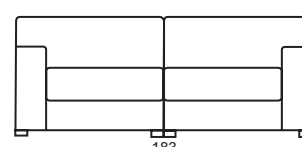
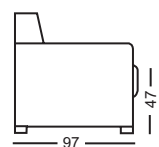
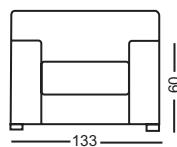
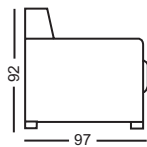

CUSCINI  
ARREDO

# BLASCO

trasformabile



Struttura in legno di abete e agglomerati di particelle di legno.

Braccia e spalliera agganciati con meccanismo a baionetta.

Sistema apertura rete tipo roller con reggiguanciali.

Rete elettrosaldata e materasso in poliuretano espanso h. cm 13

Imbottitura di poliuretano espanso a densità differenziata.

Rivestimento tessuto/ecopelle

Divano interamente sfoderabile

Inserimento chaise longue con contenitore e senza contenitore con aggiunta cm 82 alla misura del divano

# BLASCO

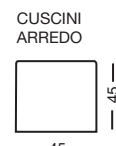
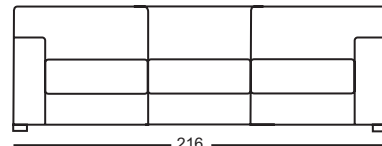
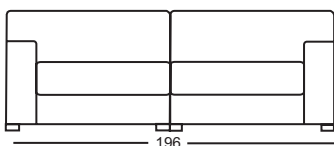
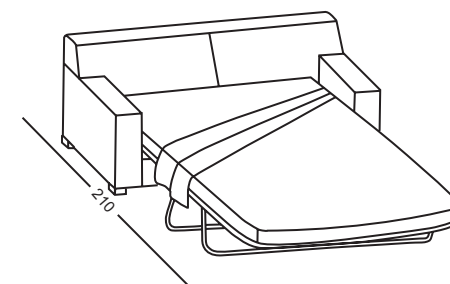
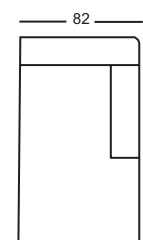
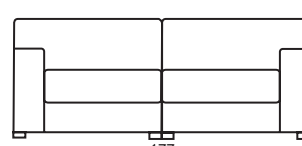
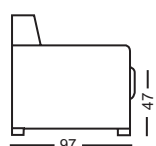
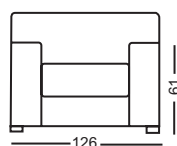
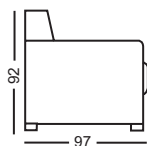

# RIBERIO

trasformabile



Struttura in legno di abete e agglomerati di particelle di legno.

Braccia e spalliera agganciati con meccanismo a baionetta.

Sistema apertura rete tipo roller con reggiguanciali.

Rete elettrosaldata e materasso in poliuretano espanso h. cm 13

Imbottitura di poliuretano espanso a densità differenziata.

Rivestimento tessuto/ecopelle

Divano interamente sfoderabile

Inserimento chaise longue con contenitore e senza contenitore con aggiunta cm 82 alla misura del divano

# RIBERIO

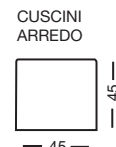
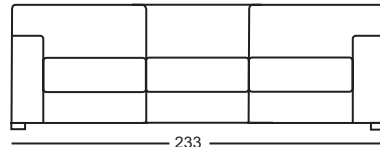
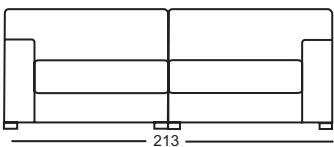
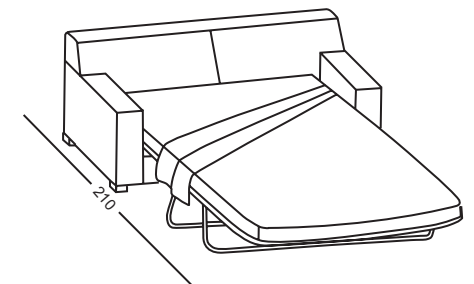
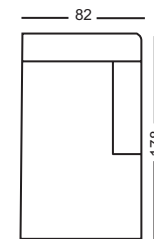
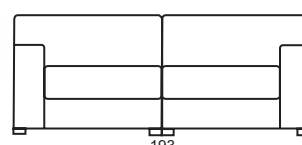
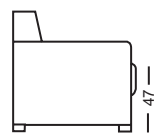
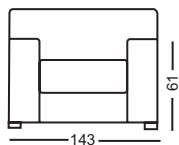
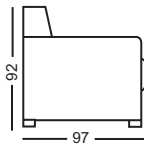

CUSCINI ARREDO

# RIBERIO

---

trasformabile





Struttura in legno di abete e agglomerati di particelle di legno.

Braccia e spalliera agganciati con meccanismo a baionetta.

Sistema apertura rete tipo roller con reggiguanciali.

Rete elettrosaldata e materasso in poliuretano espanso h. cm 13

Imbottitura di poliuretano espanso a densità differenziata.

Rivestimento tessuto/ecopelle

Divano interamente sfoderabile

Inserimento chaise longue con contenitore e senza contenitore con aggiunta cm 82 alla misura del divano

# RIBERIO

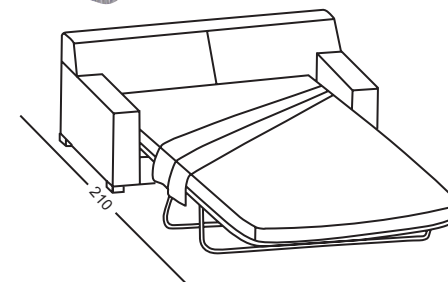
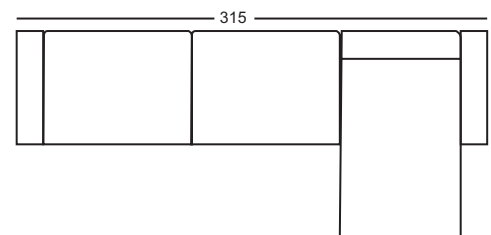
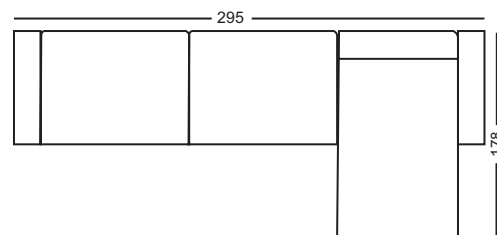
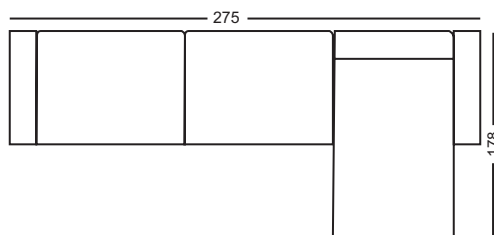
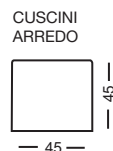
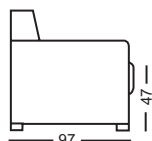
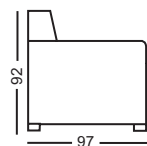

# VIVALDO

---

trasformabile



Struttura in legno di abete e agglomerati di particelle di legno.

Braccia e spalliera agganciati con meccanismo a baionetta.

Sistema apertura rete tipo roller con reggiguanciali.

Rete elettrosaldata e materasso in poliuretano espanso h. cm 13

Imbottitura di poliuretano espanso a densità differenziata.

Rivestimento tessuto/ecopelle

Divano interamente sfoderabile

Inserimento chaise longue con contenitore e senza contenitore

# VIVALDO

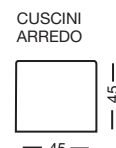
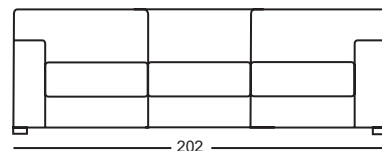
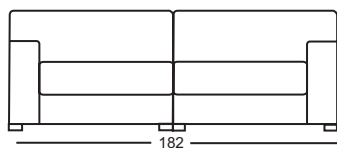
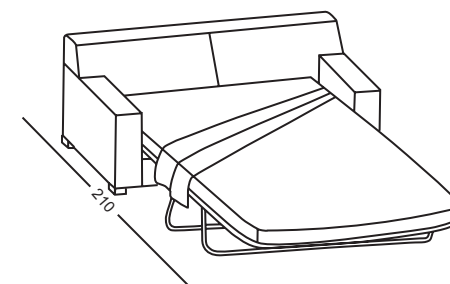
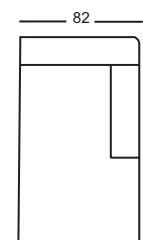
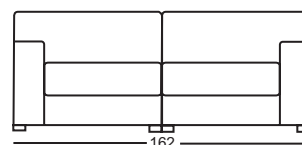
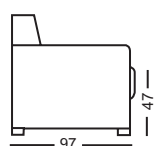
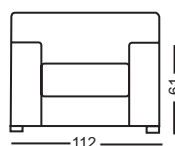
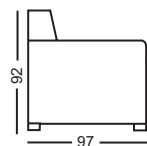

CUSCINI  
ARREDO

# REGINALDO

trasformabile



Struttura in legno di abete e agglomerati di particelle di legno.

Braccia e spalliera agganciati con meccanismo a baionetta.

Sistema apertura rete tipo roller con reggiguanciali.

Rete elettrosaldata e materasso in poliuretano espanso h. cm 13

Imbottitura di poliuretano espanso a densità differenziata.

Rivestimento tessuto/ecopelle

Divano interamente sfoderabile

Inserimento chaise longue con contenitore e senza contenitore con aggiunta cm 82 alla misura del divano

# REGINALDO

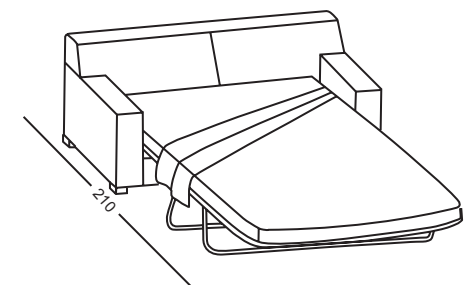
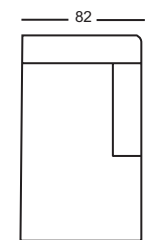
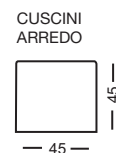
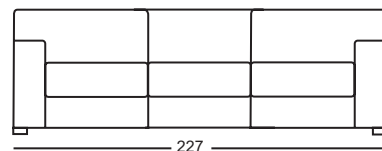
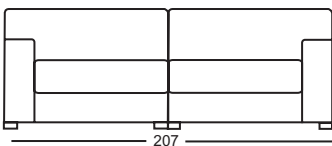
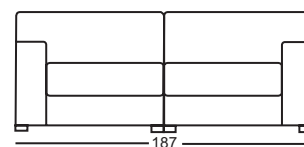
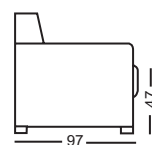
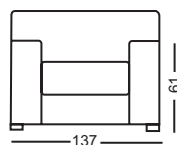
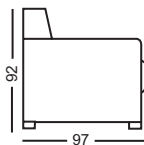

# ANACLETO

---

trasformabile

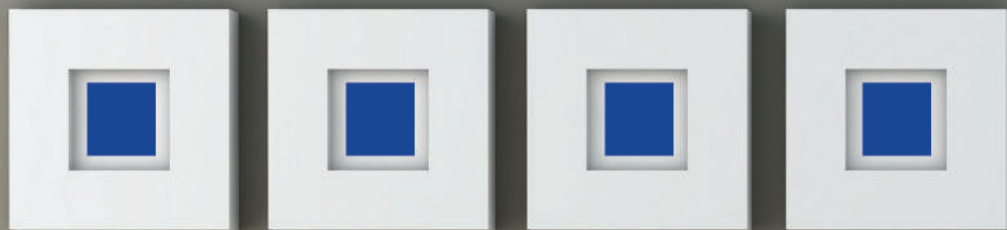

Struttura in legno di abete e agglomerati di particelle di legno.

Braccia e spalliera agganciati con meccanismo a baionetta.

Sistema apertura rete tipo roller con reggiuanciali.

Rete elettrosaldata e materasso in poliuretano espanso h. cm 13

Imbottitura di poliuretano espanso a densità differenziata.

Rivestimento tessuto/ecopelle

Divano interamente sfoderabile

Inserimento chaise longue con contenitore e senza contenitore con aggiunta cm 82 alla misura del divano

# ANACLETO

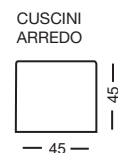
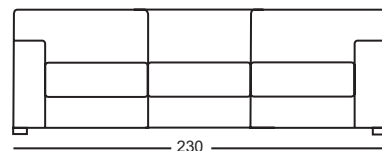
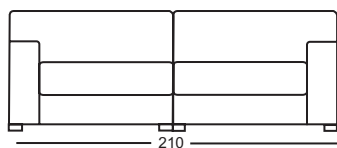
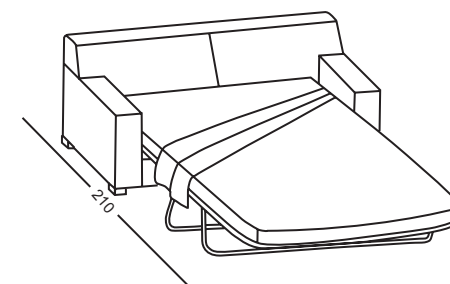
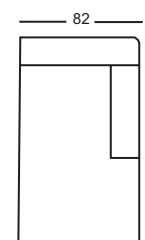
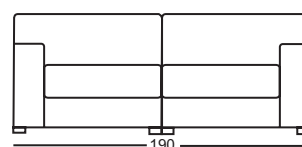
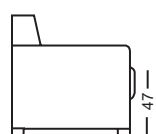
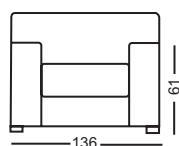
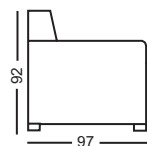

# XENOS

---

trasformabile





Struttura in legno di abete e agglomerati di particelle di legno.

Braccia e spalliera agganciati con meccanismo a baionetta.

Sistema apertura rete tipo roller con reggiguanciali.

Rete elettrosaldata e materasso in poliuretano espanso h. cm 13

Imbottitura di poliuretano espanso a densità differenziata.

Rivestimento tessuto/ecopelle

Divano interamente sfoderabile

Inserimento chaise longue con contenitore e senza contenitore con aggiunta cm 82 alla misura del divano

# XENOS

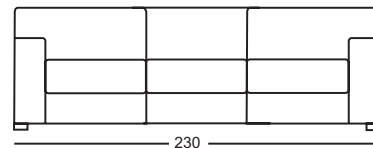
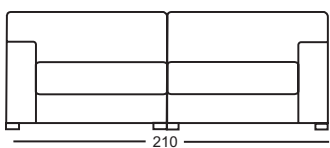
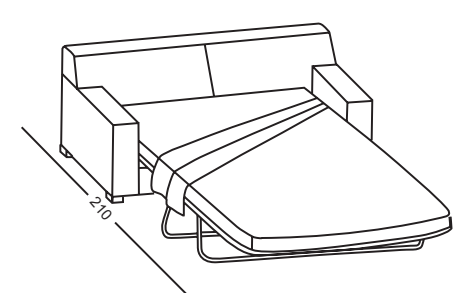
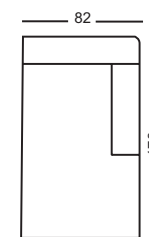
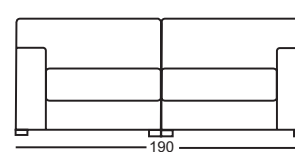
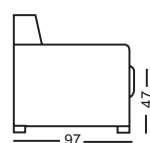
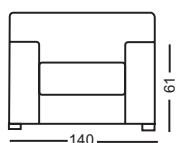
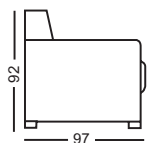

CUSCINI  
ARREDO

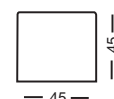

# LAURINDA

---

trasformabile



# LAURINDA



*Struttura in legno di abete e agglomerati di particelle di legno.*

*Imbottitura di poliuretano espanso a densità differenziata.*

*Inserimento 2 reti singole con movimento duplex*

*Rivestimento in tessuto*

*Divano interamente sfoderabile*

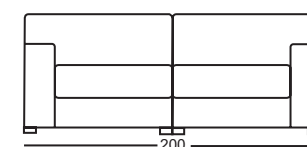
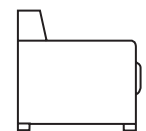
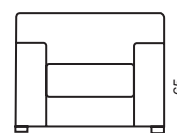
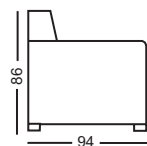
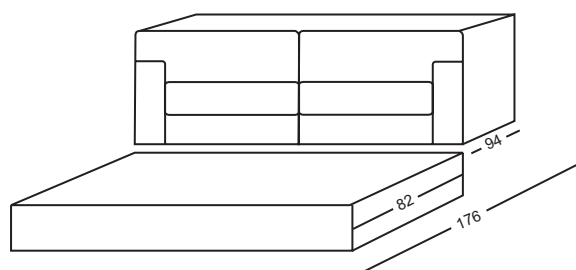

# FLORA

trasformabile



# FLORA



*Struttura in legno di abete e agglomerati di particelle di legno.*

*Imbottitura di poliuretano espanso a densità differenziata.*

*Inserimento 2 reti singole con movimento duplex*

*Rivestimento in tessuto*

*Divano interamente sfoderabile*

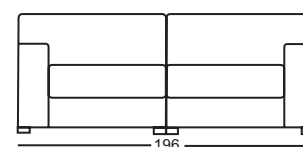
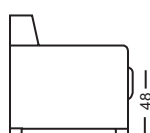
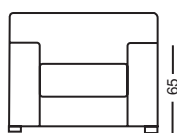
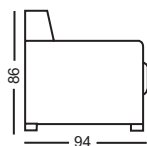

CUSCINI  
ARREDO

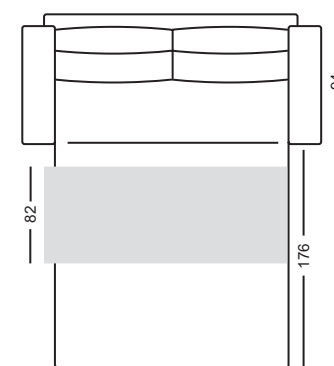
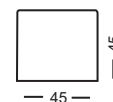

RIO

---





*Struttura in legno di abete con parti di multistrati di pioppo e agglomerati di particelle di legno con cinghie elastiche intrecciate.*

*Imbottitura di poliuretano espanso a densità differenziata.*

*Inserimento rete 3 pieghe elettrosaldata e materasso in poliuretano espanso h. cm 7*

*Rivestimento in tessuto*

*Divano con cuscini e spalliera sfoderabili*

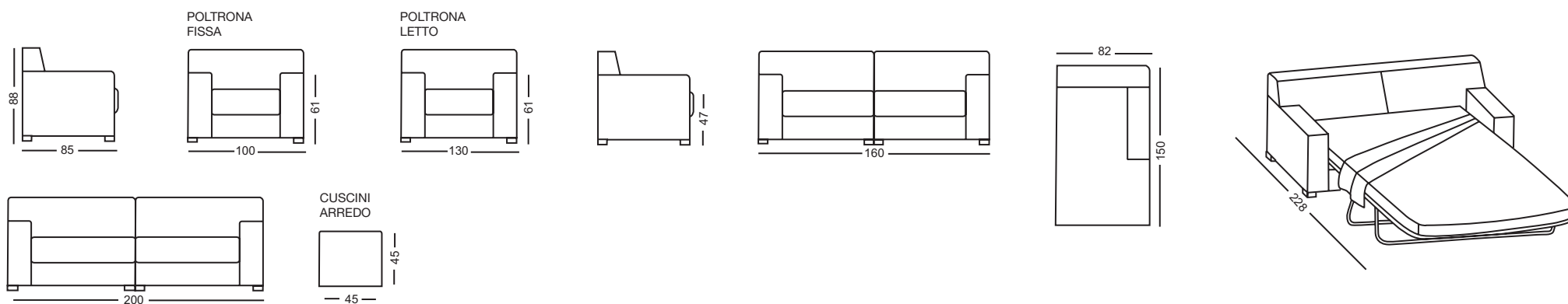

# ERNESTO

---





# ERNESTO



*Struttura in legno di abete con parti di multistrati di pioppo e agglomerati di particelle di legno con cinghie elastiche intrecciate.*

*Imbottitura di poliuretano espanso a densità differenziata.*

*Inserimento rete 3 pieghe elettrosaldata e materasso in poliuretano espanso h. cm 7*

*Rivestimento in tessuto*

*Divano con cuscini e spalliera sfoderabili*

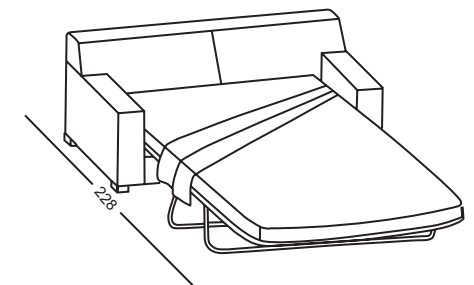
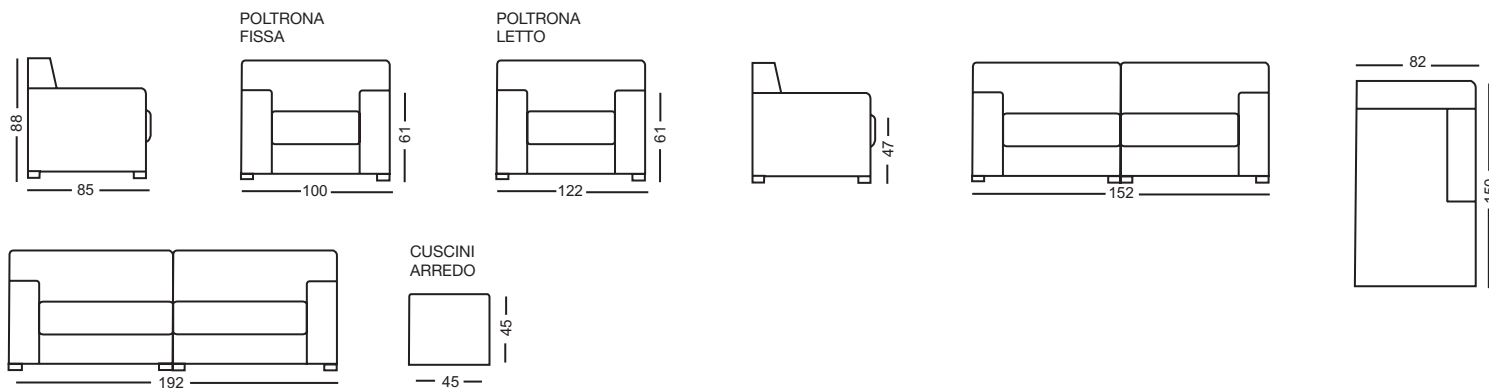

# DOMINGO

---



# DOMINGO



*Struttura in legno di abete con parti di multistrati di pioppo e agglomerati di particelle di legno con cinghie elastiche intrecciate.*

*Imbottitura di poliuretano espanso a densità differenziata.*

*Inserimento rete 3 pieghe elettrosaldata e materasso in poliuretano espanso h. cm 7*

*Rivestimento in tessuto*

*Divano con cuscini e spalliera sfoderabili*

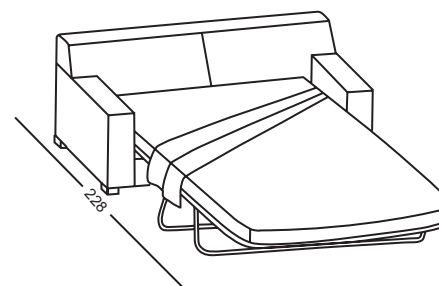
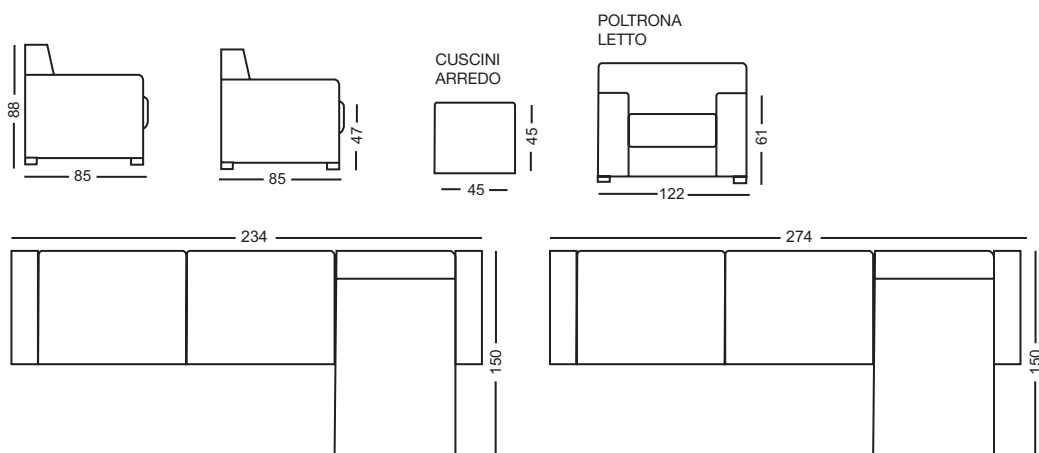

# DOMINGO

---



# DOMINGO



*Struttura in legno di abete con parti di multistrati di pioppo e agglomerati di particelle di legno con cinghie elastiche intrecciate.*

*Imbottitura di poliuretano espanso a densità differenziata.*

*Inserimento rete 3 pieghe elettrosaldata e materasso in poliuretano espanso h. cm 7*

*Rivestimento in tessuto*

*Divano con cuscini e spalliera sfoderabili*

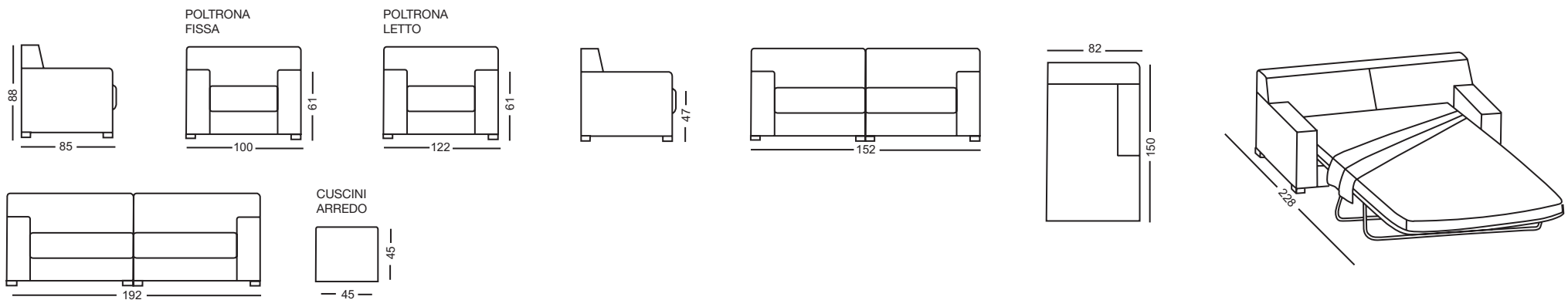

# BRASIL

---



# BRASIL



*Struttura in legno di abete con parti di multistrati di pioppo e agglomerati di particelle di legno con cinghie elastiche intrecciate.*

*Imbottitura di poliuretano espanso a densità differenziata.*

*Inserimento rete 3 pieghe elettrosaldata e materasso in poliuretano espanso h. cm 7*

*Rivestimento in tessuto*

*Divano con cuscini e spalliera sfoderabili*

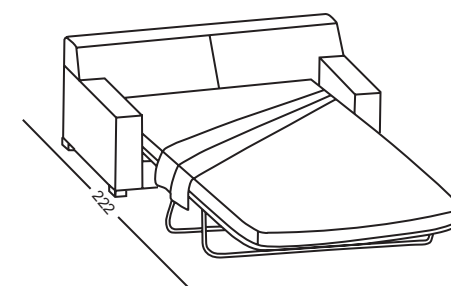
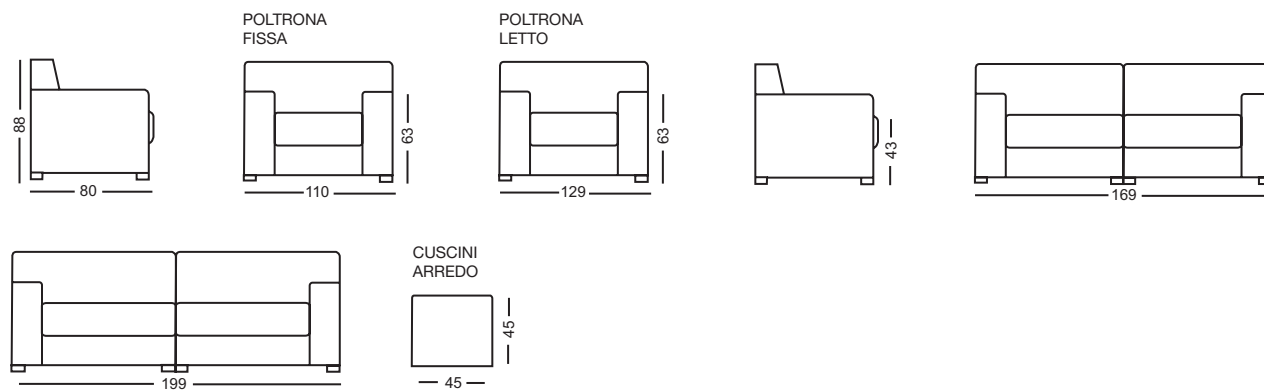

BELEN

---





# BELEN



*Struttura in legno di abete con parti di multistrati di pioppo e agglomerati di particelle di legno con cinghie elastiche intrecciate.*

*Imbottitura di poliuretano espanso a densità differenziata.*

*Inserimento rete 3 pieghe elettrosaldata e materasso in poliuretano espanso h. cm 7*

*Rivestimento in tessuto*

*Divano con cuscini e spalliera sfoderabili*

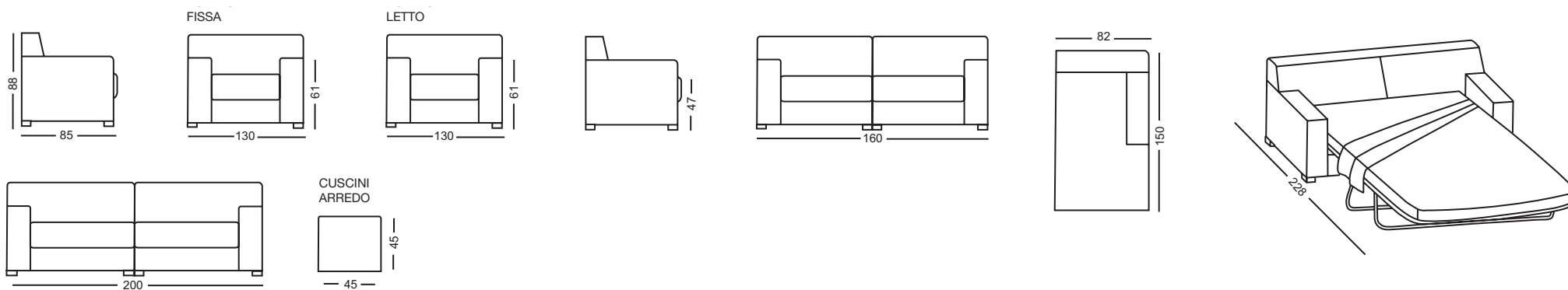

DIEGO



# DIEGO



*Struttura in legno di abete con parti di multistrati di pioppo e agglomerati di particelle di legno con cinghie elastiche intrecciate.*

*Imbottitura di poliuretano espanso a densità differenziata.*

*Inserimento rete 3 pieghe elettrosaldata e materasso in poliuretano espanso h. cm 7*

*Rivestimento in tessuto*

*Divano con cuscini e spalliera sfoderabili*

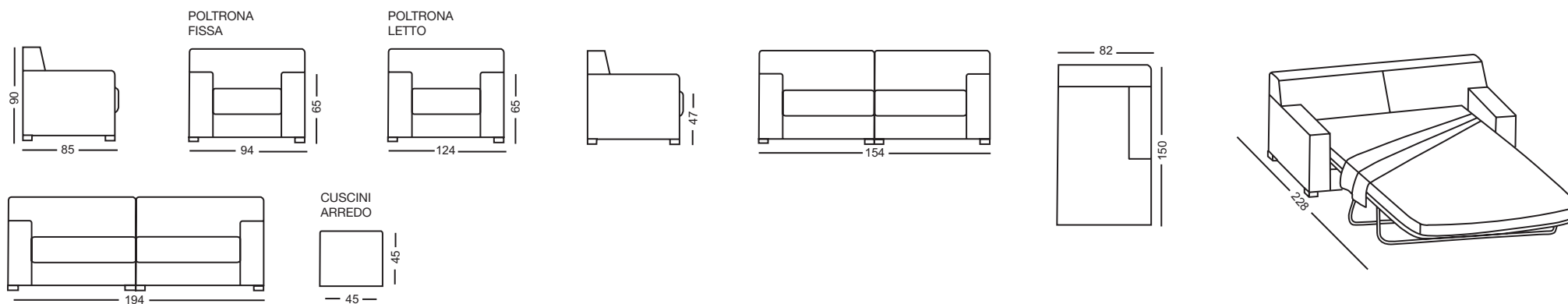

DIEGO

---



# DIEGO



*Struttura in legno di abete con parti di multistrati di pioppo e agglomerati di particelle di legno con cinghie elastiche intrecciate.*

*Imbottitura di poliuretano espanso a densità differenziata.*

*Inserimento rete 3 pieghe elettrosaldata e materasso in poliuretano espanso h. cm 7*

*Rivestimento in tessuto*

*Divano con cuscini e spalliera sfoderabili*

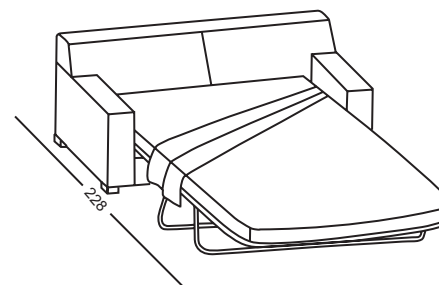
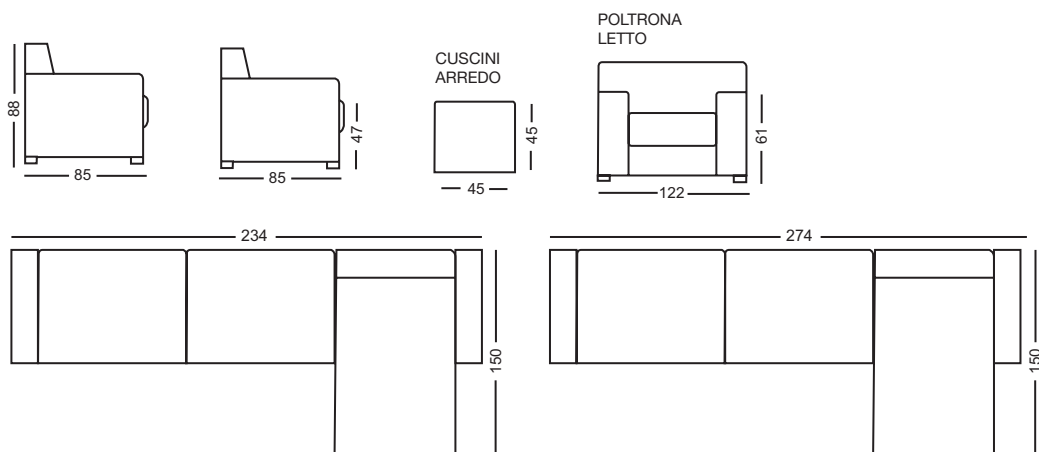

# ACCESSORI

## Piumone

cm 240 x 270

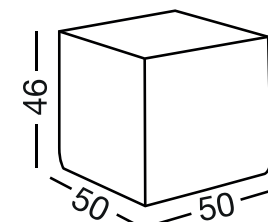
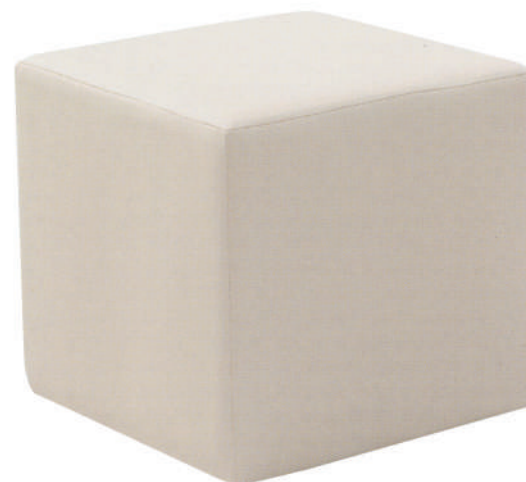
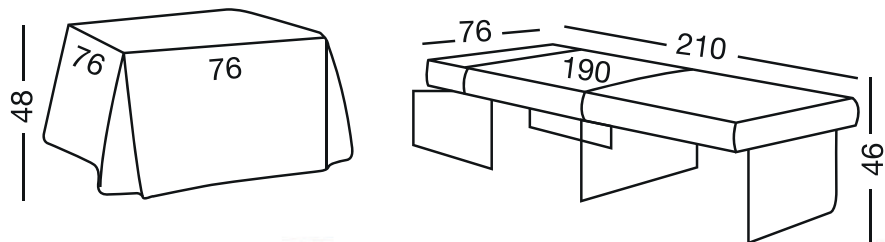

## Quirino

## Eliberto



*Quirino:  
Pouff trasformabile  
con rete elettrosaldata  
e materasso in poliuretano  
espanso h. cm 10.*

*Rivestimento tessuto  
interamente sfoderabile.*

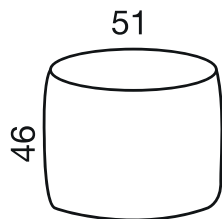

Olinda

*Olinda:*  
*Imbottitura in polistirolo.*  
*Rivestimento in tessuto/ecopelle.*  
*Sfoderabile.*



Hogo

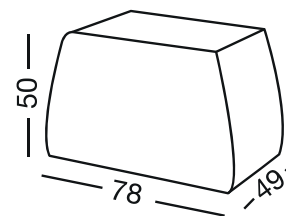

*Hogo/Oto:*  
*Struttura in legno di abete*  
*e agglomerati di particelle di legno.*  
*Imbottitura di poliuretano espanso*  
*a densità differenziata.*  
*Rivestimento in tessuto/ecopelle.*



Oto



Basilio

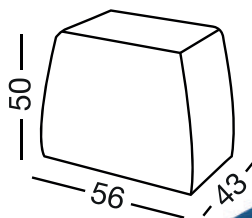

*Struttura in legno di abete e agglomerati di particelle di legno*  
*Imbottitura di poliuretano espanso a densità differenziata*  
*Rivestimento in tessuto/ecopelle*



Evaristo

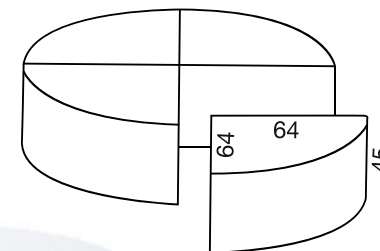



**GESAP**  
SALOTTI

C.da Piano di Corte s.n.c. - 92020 San Giovanni Gemini (AG) - Tel./fax +39 0922 901591 - ge.sa.p.srl@tiscali.it